

Cariboni  
group

# SPOON



# SPOON

Design by  
Alfonso Femia/AF\*Design



## Cariboni Group S.p.A.

### SALES OFFICE AND WAREHOUSE

Via della Tecnica, 19  
23875 Osnago (Lc)  
Tel. +39 039 95211  
[info@caribonigroup.com](mailto:info@caribonigroup.com)

### REGISTERED OFFICE AND FACTORY

Via G.A. Prato, 22  
38068 Rovereto (Tn)  
Tel. +39 0464 422247  
[info@caribonigroup.com](mailto:info@caribonigroup.com)

### CARIBONI LITE FRANCE

Z.A DU Pré de la Dame Jeanne,  
Avenue de la Dame Jeanne,  
Zone 2 \_ Bât J  
60128 Plailly  
Tel. +33 3 44740380  
[cariboni.lite@cariboni.fr](mailto:cariboni.lite@cariboni.fr)

## Associations



Associazione Italiana di Illuminazione.  
Company of Italian Lighting Association.



### FEDERLEGNOARREDO

Assoluce, associazione di FederlegnoArredo cui aderiscono le aziende italiane produttrici di apparecchi di illuminazione.

Assoluce, an association of FederlegnoArredo whose members are Italian lighting manufacturers.



Consorzio per la raccolta e lo smaltimento delle apparecchiature di illuminazione.

Consortium for collection and waste of lighting system equipments.



Associazione francese dei designer della luce e dell'illuminazione.

Company of French Lighting designer 's Association.



UNI Ente Nazionale Italiano di normazione.

UNI Italian National Standardization Authority.



Associazione Nazionale Produttori Illuminazione.  
National Association Lighting Manufacturer.



UAI: Certificazione rilasciata dall'Associazione Unione Astrofili Italiani agli apparecchi valutati anti-inquinamento luminoso.

UAI: Certification issued by the Italian Astronomy Lovers Union association for those fixtures which are esteemed as "anti-lighting-pollution".



Società Italiana Gallerie.

Italian Tunnelling Society.



Confederazione generale dell'industria italiana.  
General Confederation of Italian Industry

## Index

Intro	6
Technical information	16
Smart lighting	40
Eco-Centric Lighting	42

## CREDITS

MARKETING DEPARTMENT

Anna Magni  
Francesca Mauri

ART DIRECTION AND LAYOUT

Gag Srl Società Benefit



“La sfida è quella di riportare sugli spazi pubblici il valore del paesaggio”

“The challenge is to bring back to public spaces the value of the landscape”

Alfonso Femia







# CO- DESIGN

Innestare un processo di  
"contaminazione".  
Tutti imparano qualcosa,  
mettendo il progetto al centro.

Triggering a process of  
'contamination'.  
Everyone learns something,  
focusing on the project.





# SPOON

Nasce portando una nota poetica  
all'interno di un settore tecnico,  
con la volontà di abitare lo spazio.

It was born by introducing a poetic  
note within a technical sector,  
with the desire to inhabit space.

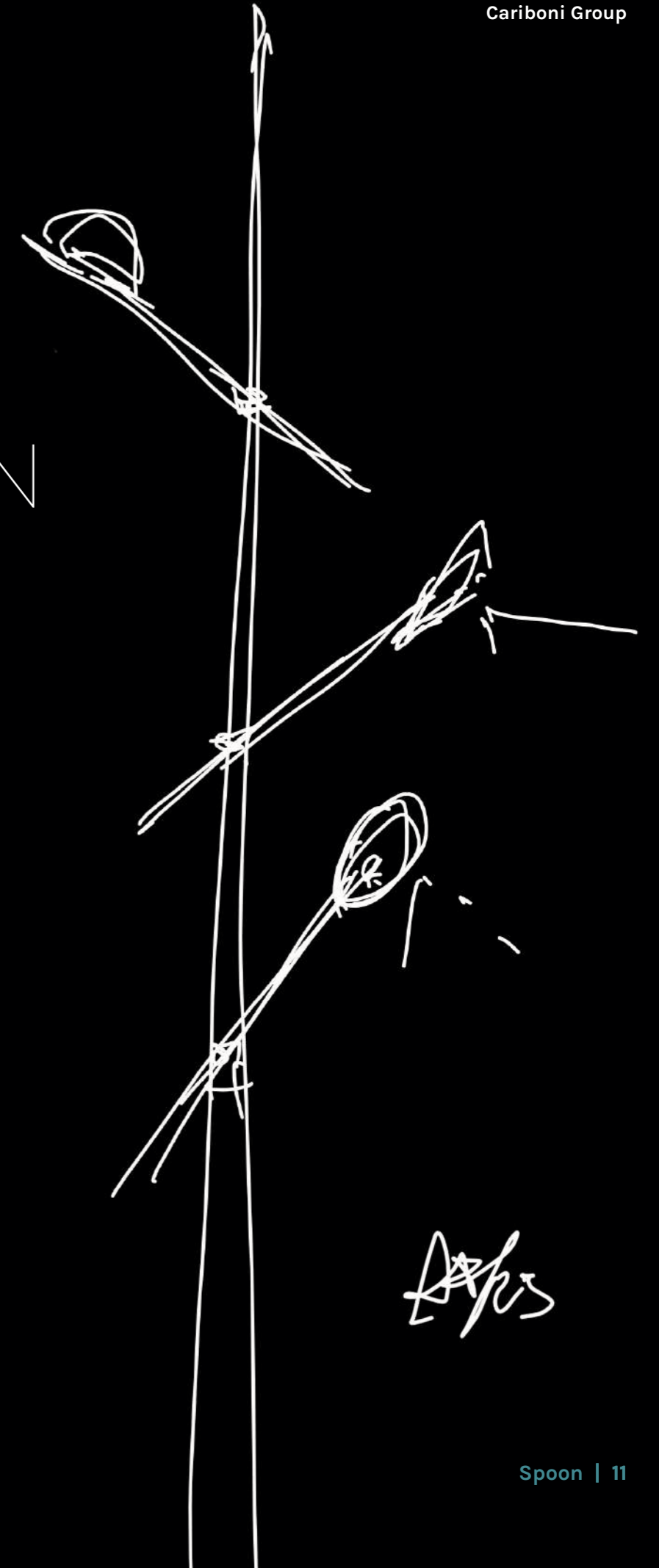



## Spoon

Nella definizione del comfort urbano è necessario sincronizzare l'illuminazione agli scenari contemporanei.

La nuova linea definisce lampade urbane capaci di dialogare e di reagire alle situazioni mutevoli, non oggetti indifferenti, ma integrati e coerenti alla riscrittura delle città.

In defining urban comfort, it is necessary to synchronize lighting with contemporary scenarios.

The new line defines urban lamps capable of communicating and reacting to changing situations, not indifferent objects, but objects integrated and coherent with the rewriting of cities.

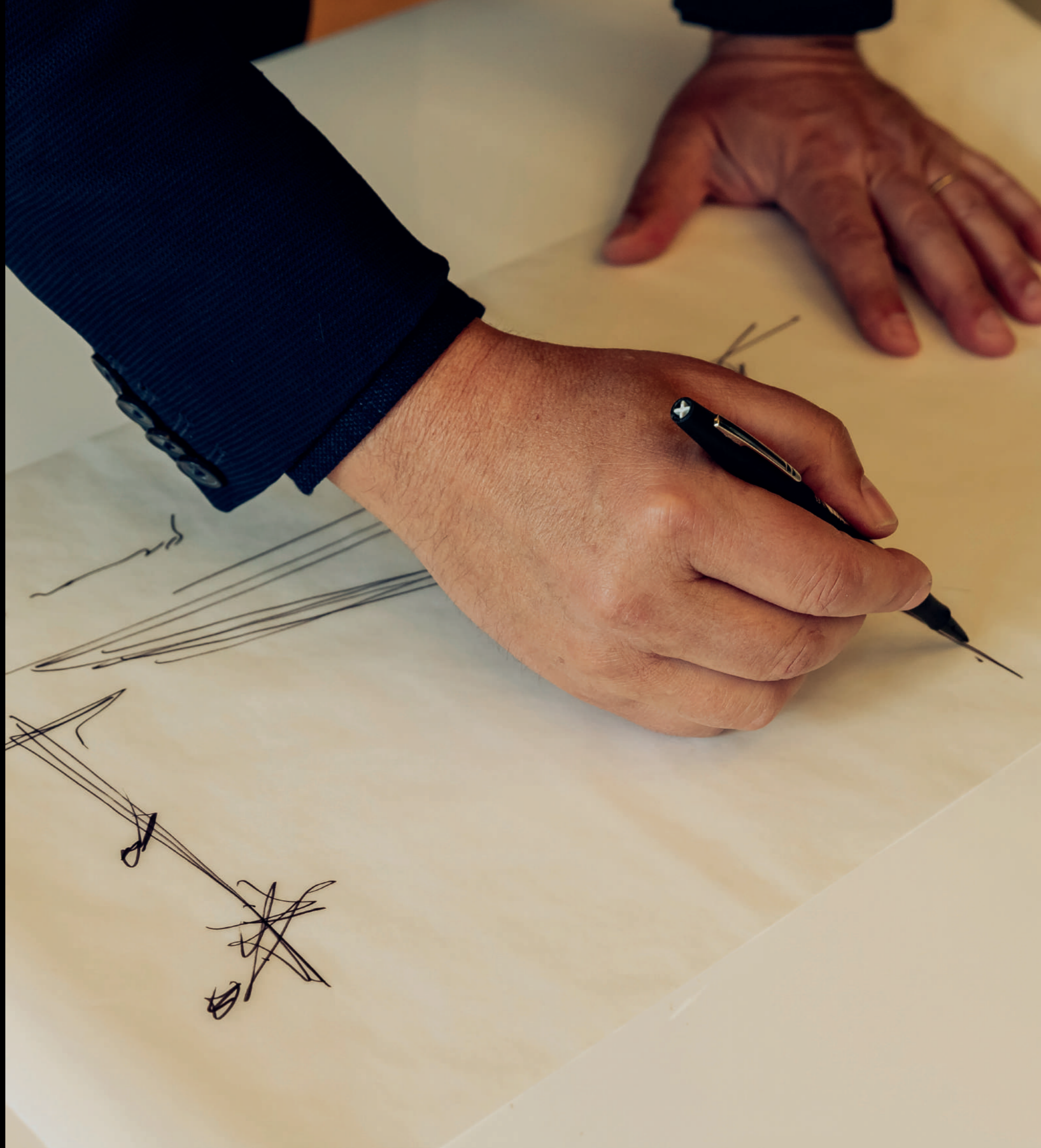



Spoon risponde alla sfida di progettare un elemento dinamico, quasi un corpo vivente declinabile alle diverse scale, geometrie e posizioni tra lo spazio specifico e l'ambiente complessivo.

Spoon responds to the challenge of designing a dynamic element, almost a living body, that can be adapted to the different scales, geometries and positions between the specific space and the overall environment.

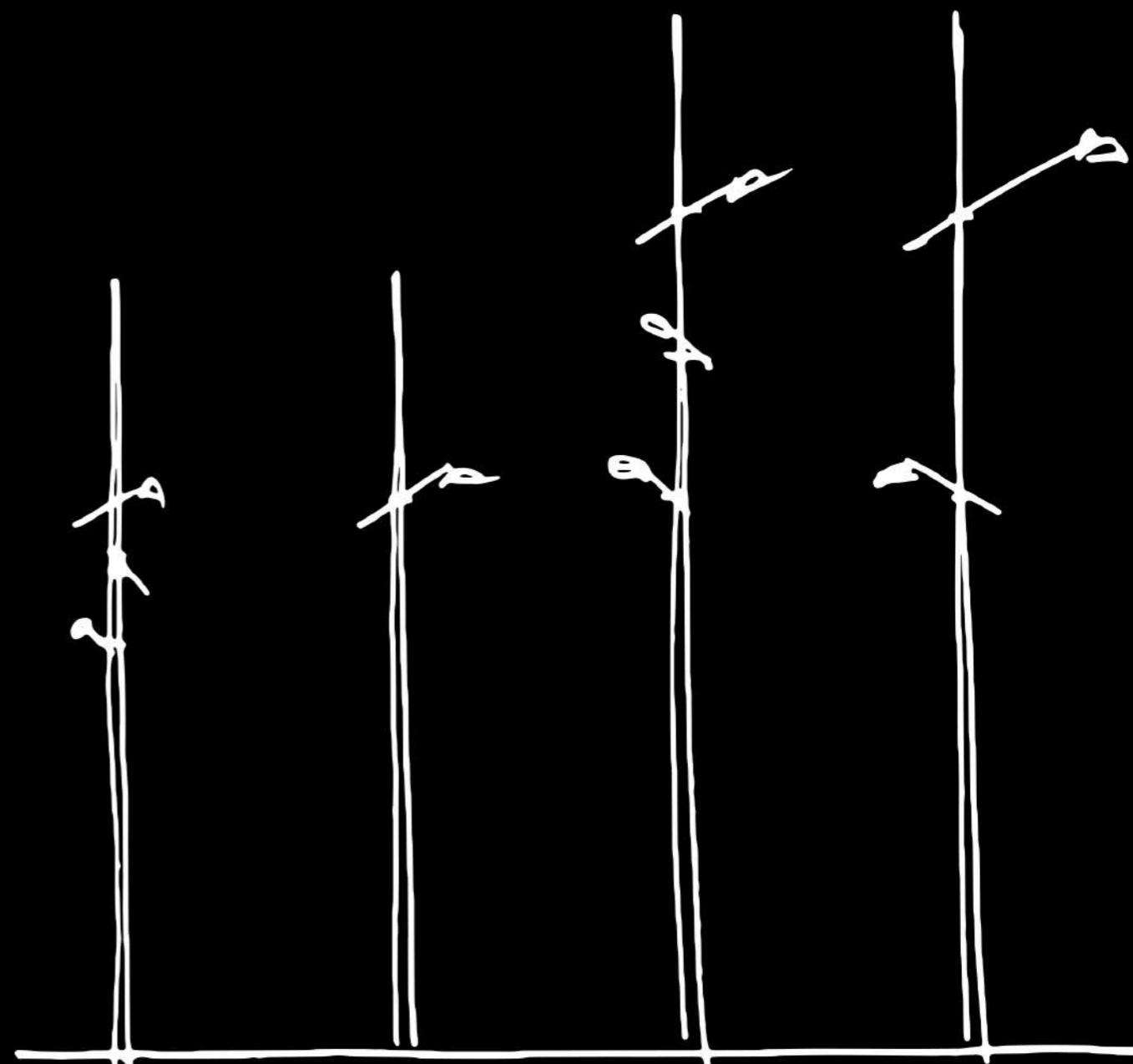
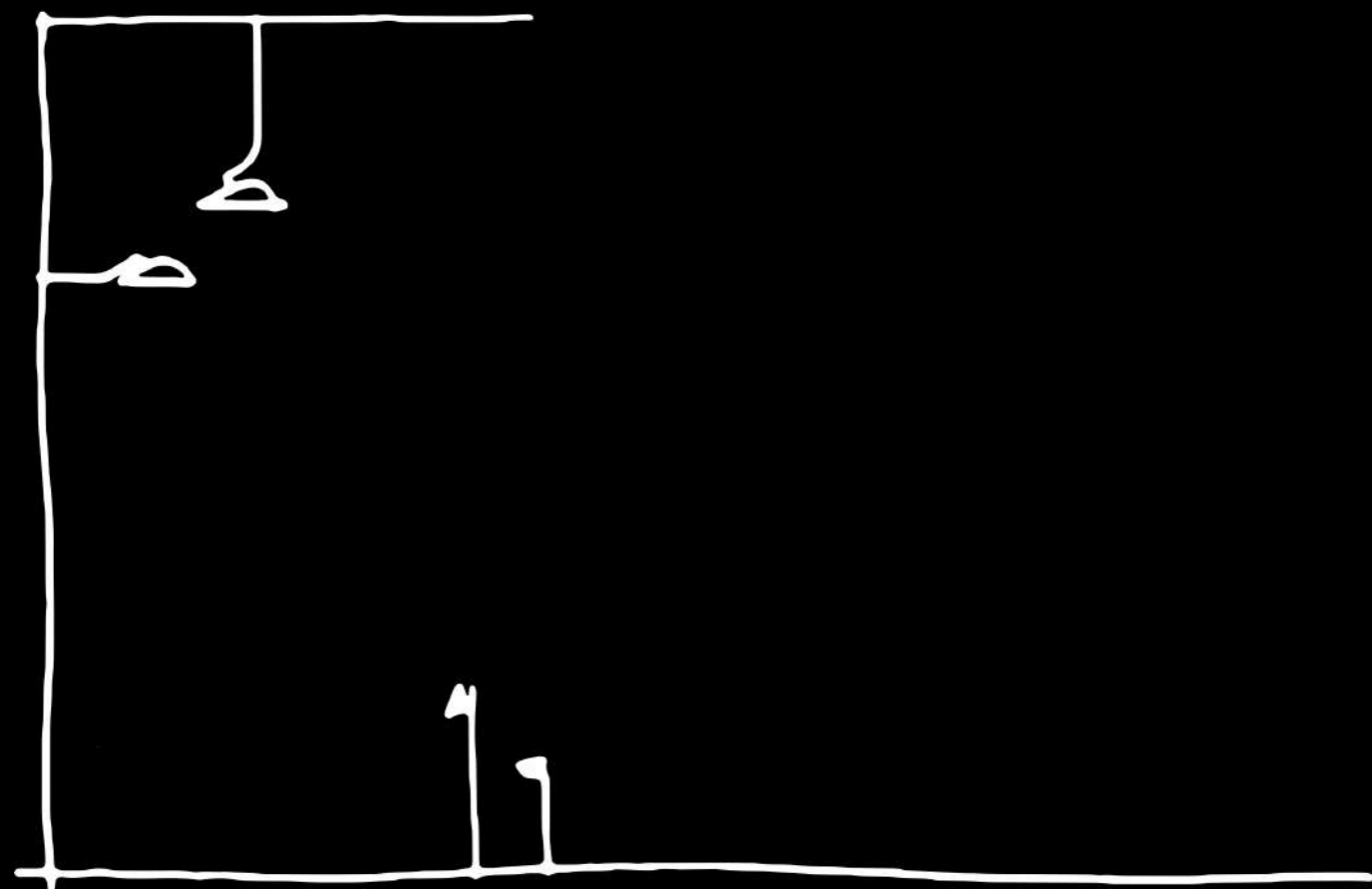



# SPOON



SPOON è un nuovo sistema per l'illuminazione urbana, declinabile a diverse scale e coerente ai mutevoli scenari urbani contemporanei.

Design by Alfonso Femia/AF\*Design.

SPOON is a new urban lighting system that can be adapted to different scales and is consistent with the changing contemporary urban scenarios. Design by Alfonso Femia/AF\*Design.



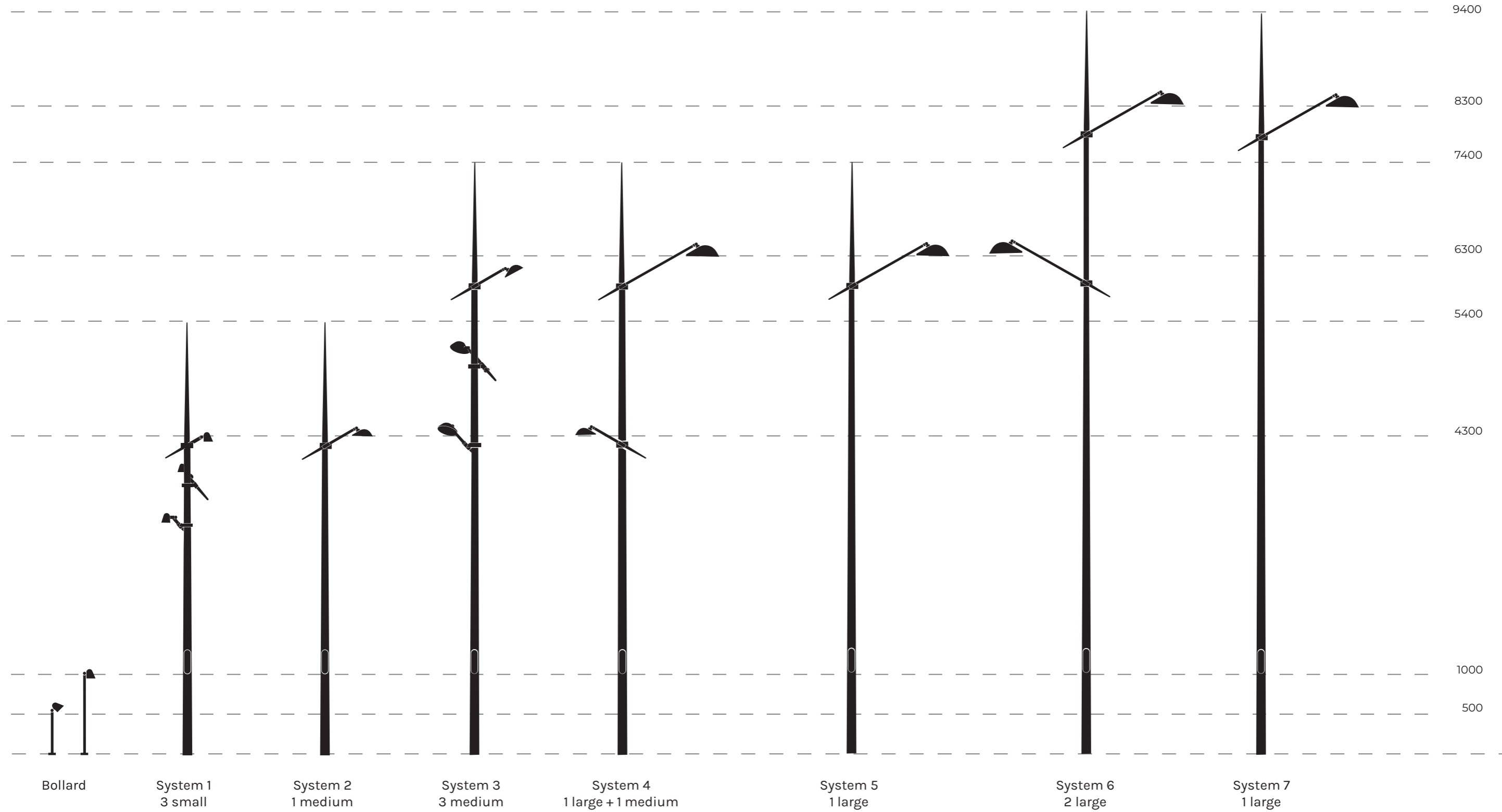



# Spoon Pole Configurations

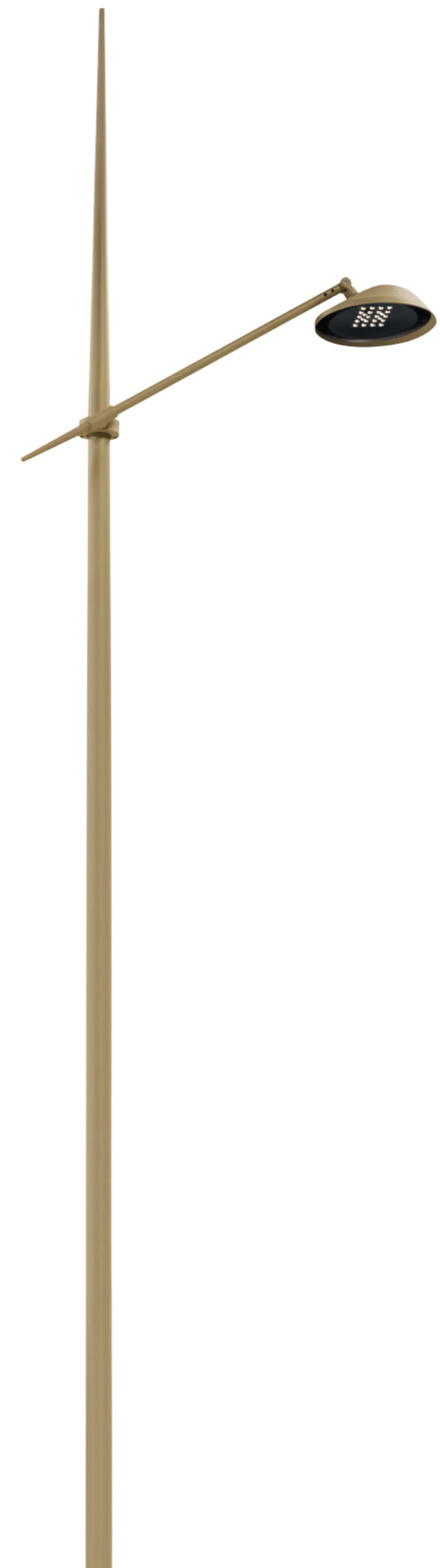
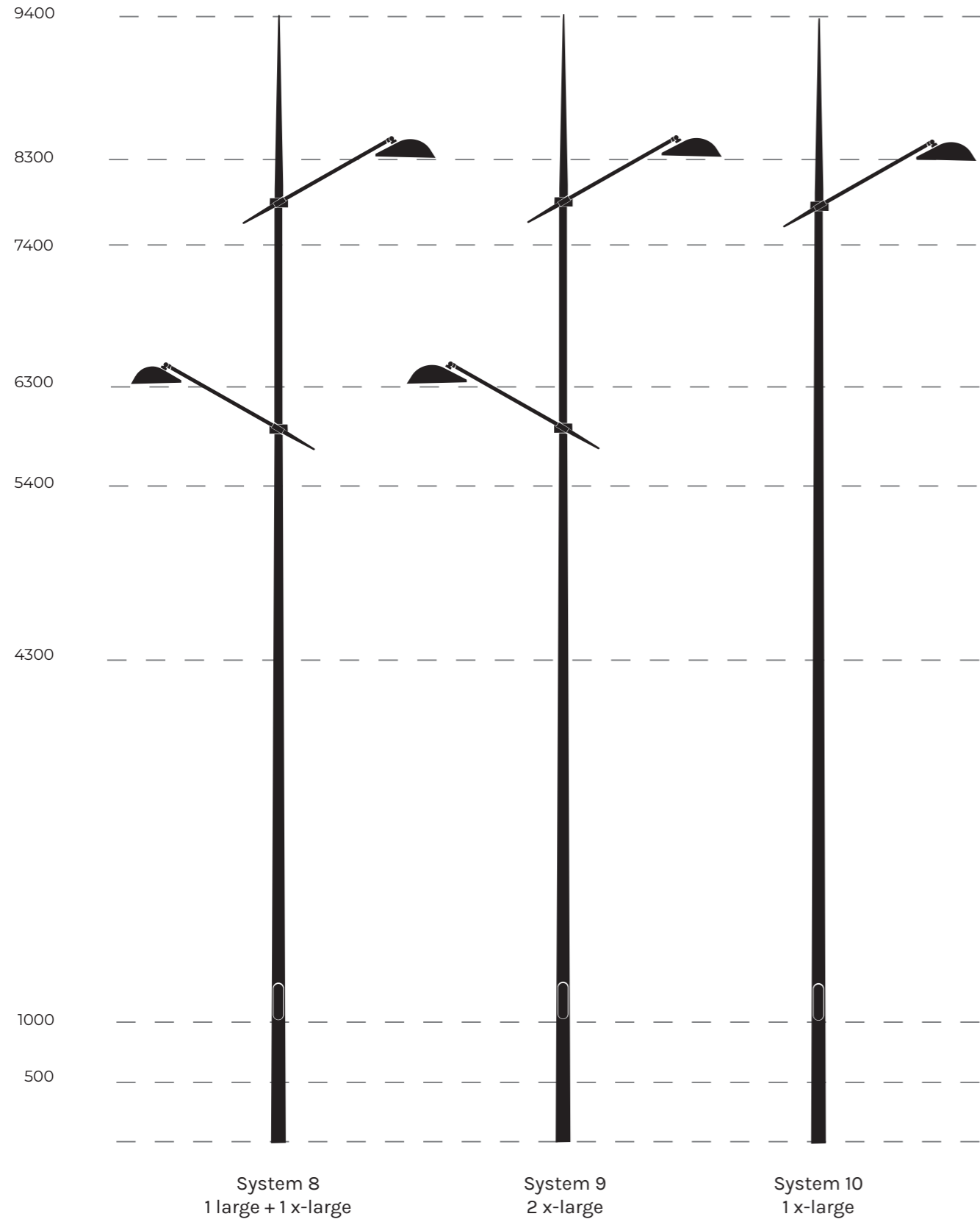

220-240V 24V (RGBW / TW)	50 60Hz	CL II	IP66	IK09	ta -30°C +50°C
-----------------------------	------------	-------	------	------	----------------------



## DATI PRESTAZIONALI / PERFORMANCE DATA

**Flusso apparecchio** / Fitting flux:  
770 - 17385 lm

**Potenza apparecchio** / Fitting power:  
8 - 144 W

**Indice di resa cromatica** / Colour Rendering Index:  
≥ 80, SDCM ≤ 3 (medium, large, x-large)  
≥ 90, SDCM ≤ 3 (small)

**Illuminazione intelligente** / Smart lighting:  
mezzanotte virtuale, DALI. Su richiesta ZHAGA UP (large, x-large) / virtual midnight, DALI. On request ZHAGA UP (large, x-large)

## MATERIALI / MATERIALS

**Corpo, sistemi di fissaggio e puntali** / Body, fitting systems and rods:  
pressofusione di lega d'alluminio UNI EN AB 47100 (contenuto rame < 1%) / die-cast aluminium alloy UNI EN AB 47100 (copper content < 1%)

**Schermo** / Screen:  
vetro piano temprato / tempered flat glass

**Gruppo ottico** / Optical unit:  
lente in tecnopolimero ad alta trasparenza (small), lenti in PMMA ad alta trasparenza (medium, large, x-large) / highly transparent technopolymer lens (small), PMMA high transparent lenses (medium, large, x-large)

**Finitura** / Finish:  
fosfocromatazione e verniciatura in polveri di poliestere realizzata in 16 fasi per la miglior resistenza agli agenti atmosferici / phospho-chromatation treated and polyester powder-coated in 16 phases to increase weather resistance

### TEMPERATURA COLORE COLOUR TEMPERATURE

 3000 K

### ECO-CENTRIC LIGHTING (ECL)

(ONLY FOR STREET OPTICS, LARGE AND X-LARGE VERSIONS)

#### BLUE FREE LIGHT:

PC-AMBER 0,7%  $\Sigma R$  ( $\lambda < 500\text{NM}$ ) — CRI 40  
1800 K 4,3%  $\Sigma R$  ( $\lambda < 500\text{NM}$ ) — CRI 70

#### SWITCHABLE WHITE LIGHT:

1800K / 3000K

### COLORI / COLOURS

 CHAMPAGNE

## CARATTERISTICHE / FEATURES

### Peso massimo / Max weight:

6 kg (bollard); 4.5 kg (small); 7 kg (medium); 9 kg (large);  
10 kg (x-large)

**Alimentazione elettronica** / Electronic power supply:  
inclusa / included

**Precablaggio** / Pre-wiring:  
prodotto precablato con cavo e connettore / pre-wired product with cable and connector

**Resistenza sovratensioni** / Surge Protection Device:  
10kV MC/MD (medium, large, x-large)

**Installazione** / Installation:  
terra, palo, parete, sottoportico  
ground, pole, wall, arcade





OTTICHE / OPTICS

C 10° Narrow Beam

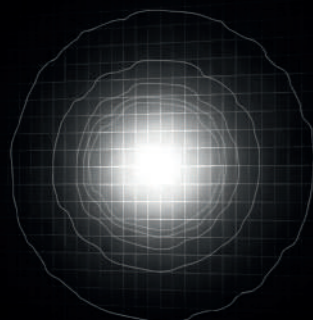

D 45° Wide Beam

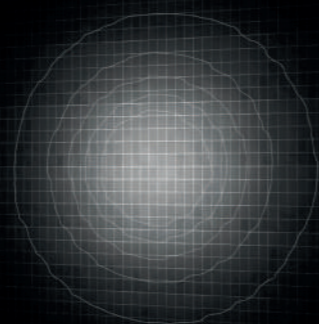

M 25° Medium Beam

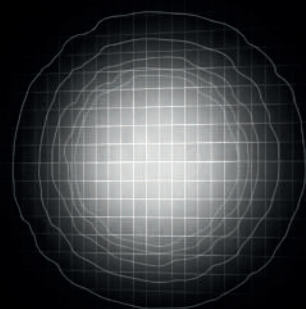

U-D 90° Diffused Beam

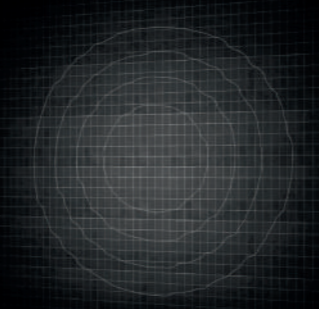

AS-D Asymmetric Diffused Beam

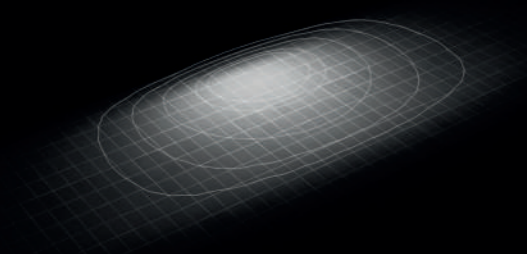

Spoon  
Bollard

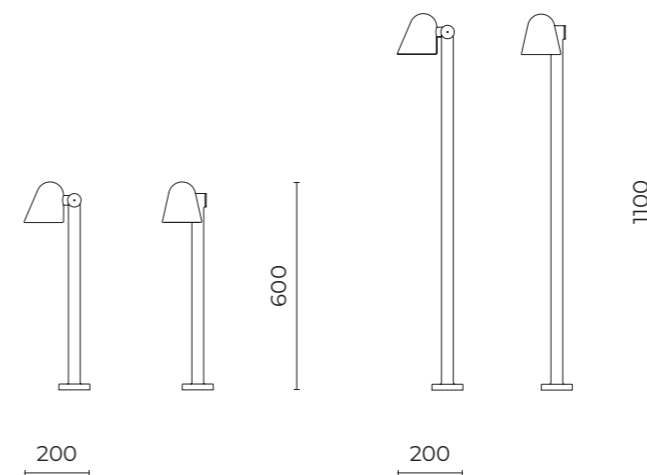

BOLLARD  
1000



BOLLARD  
500



DATI TECNICI / TECHNICAL DATA

**Installazione / Installation:**  
terra / ground

**Inclinazione / Inclination:**  
0° ÷ 180°, rotazione ±30°  
0° ÷ 180°, rotation ±30°

ACCESSORI / ACCESSORIES

**06PY999X0**  
**Kit tirafondi**  
Anchoring bolts kit 30



# Spoon System

## DATI TECNICI / TECHNICAL DATA

**Installazione / Installation:**  
palo conico con puntale / conical pole with rod

**Inclinazione / Inclination:**  
+120° ÷ -60° (small)  
0° ÷ +90° (medium, large, x-large)

### SMALL

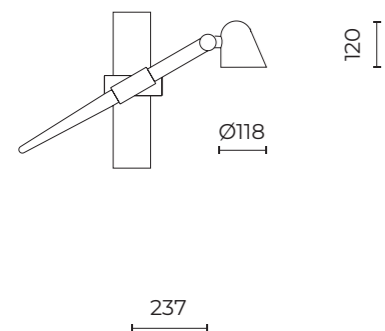

### MEDIUM

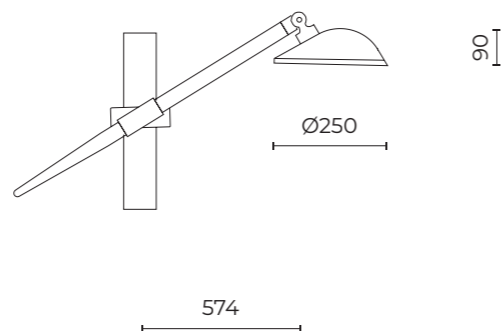

### LARGE

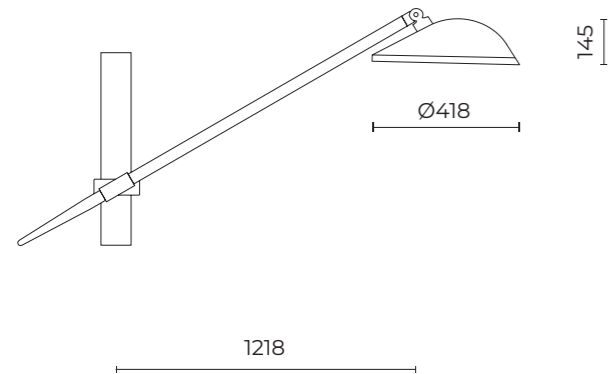

### XLARGE

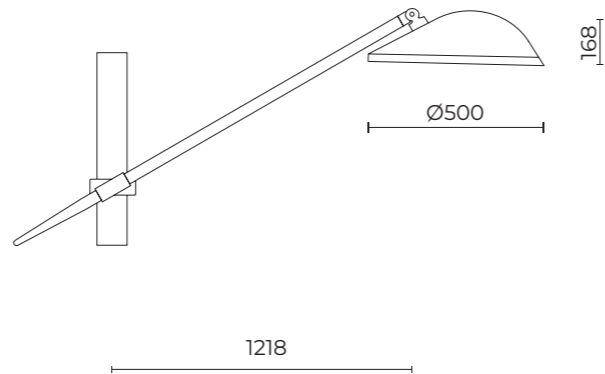



CONFIGURAZIONI / CONFIGURATIONS:

**Spoon System 1**

Palo con puntale h. tot. 5400 mm,  
3 Spoon Small  
Pole with rod h. tot. 5400 mm,  
3 Spoon Small

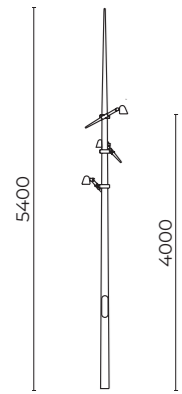

329

**Spoon System 2**

Palo con puntale h. tot. 5400 mm,  
1 Spoon Medium  
Pole with rod h. tot. 5400 mm,  
1 Spoon Medium

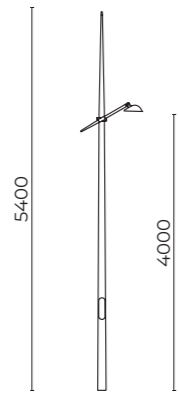

574

**Spoon System 3**

Palo con puntale h. tot. 7400 mm,  
3 Spoon Medium  
Pole with rod h. tot. 7400 mm,  
3 Spoon Medium

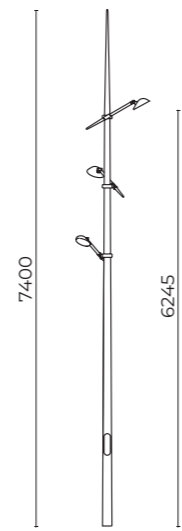

574

**Spoon System 4**

Palo con puntale h. tot. 7400 mm,  
1 Spoon Medium, 1 Spoon Large  
Pole with rod h. tot. 7400 mm,  
1 Spoon Medium, 1 Spoon Large

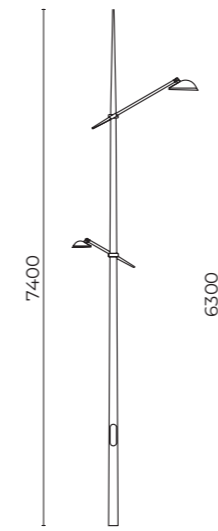

574 1218

**Spoon System 5**

Palo con puntale h. tot. 7400 mm,  
1 Spoon Large  
Pole with rod h. tot. 7400 mm,  
1 Spoon Large

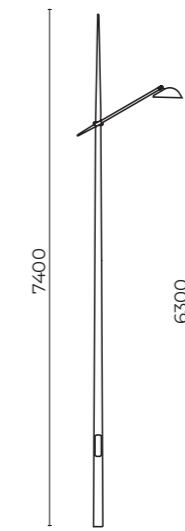

1218

**Spoon System 6**

Palo con puntale h. tot. 9400 mm,  
2 Spoon Large  
Pole with rod h. tot. 9400 mm,  
2 Spoon Large

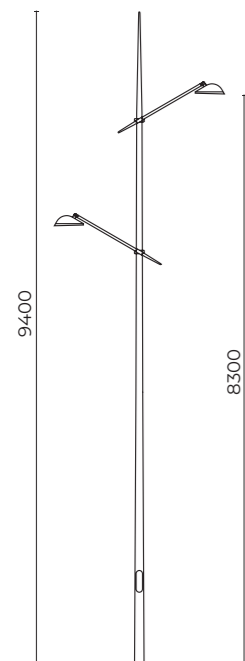

574 1218

**Spoon System 7**

Palo con puntale h. tot. 9400 mm,  
1 Spoon Large  
Pole with rod h. tot. 9400 mm,  
1 Spoon Large



1218

**Spoon System 8**

Palo con puntale h. tot. 9400 mm,  
1 Spoon Large, 1 Spoon X-Large  
Pole with rod h. tot. 9400 mm,  
1 Spoon Large, 1 Spoon X-Large

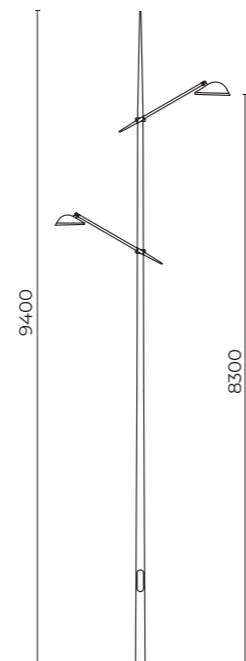

574 1218

**Spoon System 9**

Palo con puntale h. tot. 9400 mm,  
2 Spoon X-Large  
Pole with rod h. tot. 9400 mm,  
2 Spoon X-Large

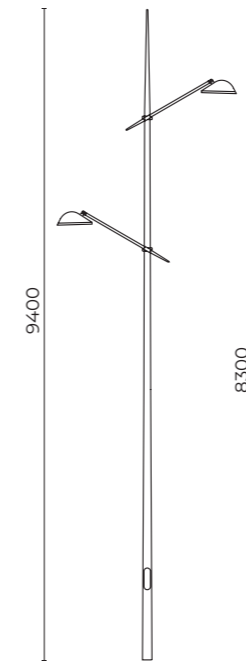

574 1218

**Spoon System 10**

Palo con puntale h. tot. 9400 mm,  
1 Spoon X-Large  
Pole with rod h. tot. 9400 mm,  
1 Spoon X-Large

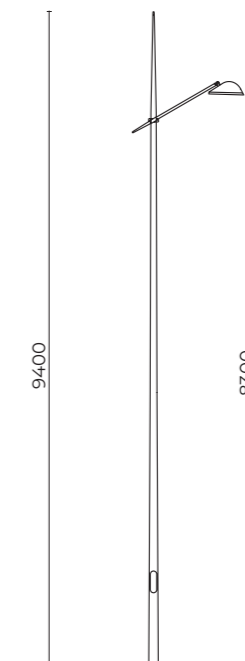

1218

Spoon

OTTICHE / OPTICS

C 10° Narrow Beam

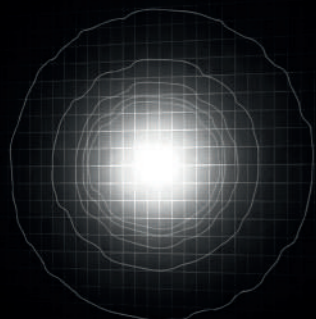

M 25° Medium Beam

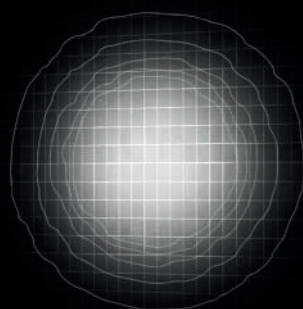

D 45° Wide Beam

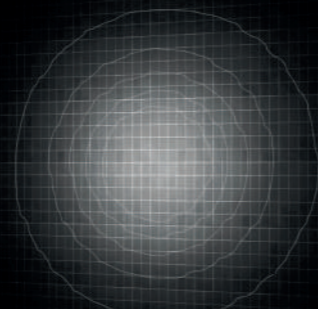

U-D 90° Diffused Beam

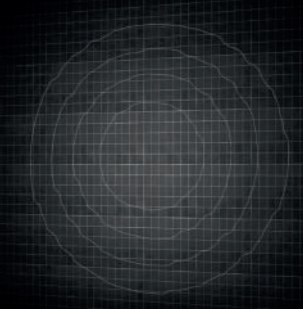

SPOON SMALL

Spoon System





OTTICHE / OPTICS

SPOON MEDIUM / LARGE / X-LARGE

C 11° Narrow Beam

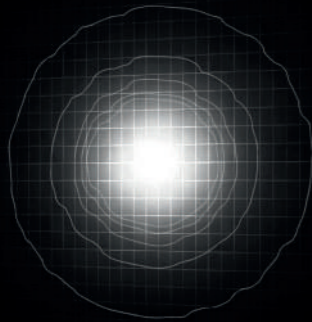

D 40° Wide Beam

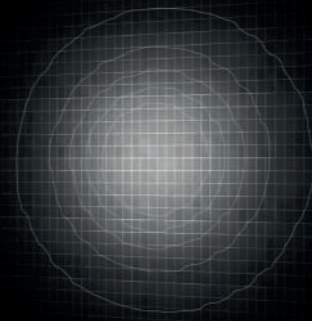

M 25° Medium Beam

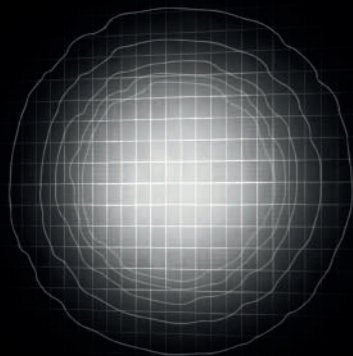

U-D 90° Diffused Beam

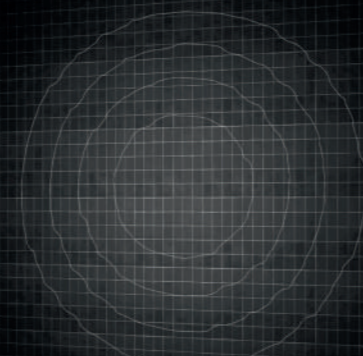

LT-C1 Cycle Path  
L / H = 0,5

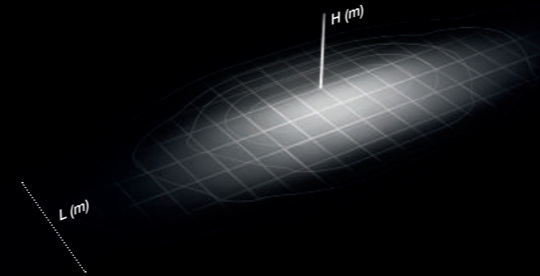

ST-02 Narrow Street  
L / H = 0,75

ECL

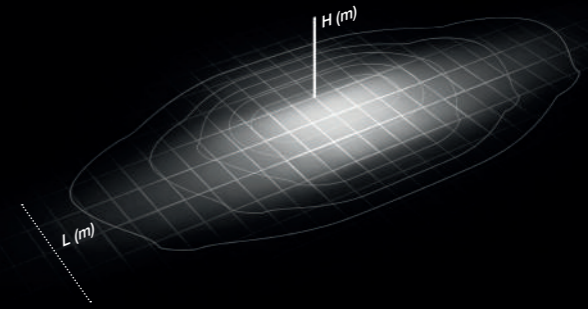

ME-06 Medium Street with sidewalk  
L / H = 1

ECL

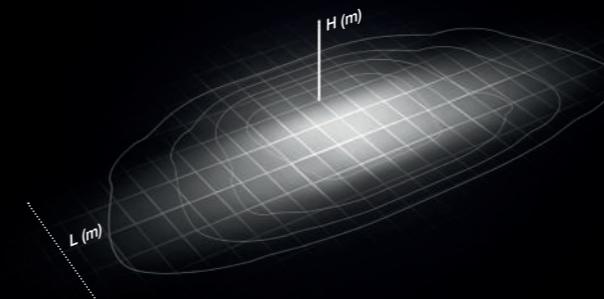

LA-03 Wide Street  
L / H = 1,25

ECL

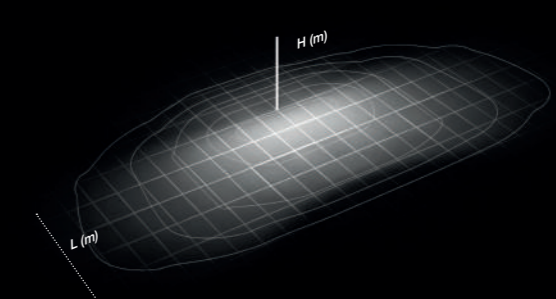

PB-01 Low Pole  
L / H = 2

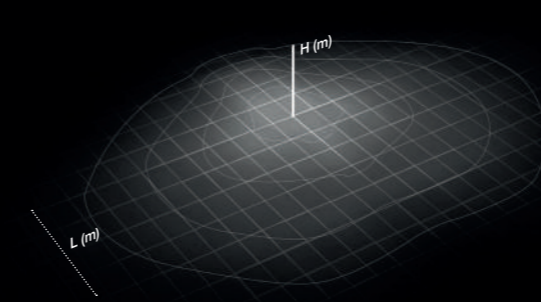

LT-64 Asymmetric Beam with backlight  
L / H = 2

ECL

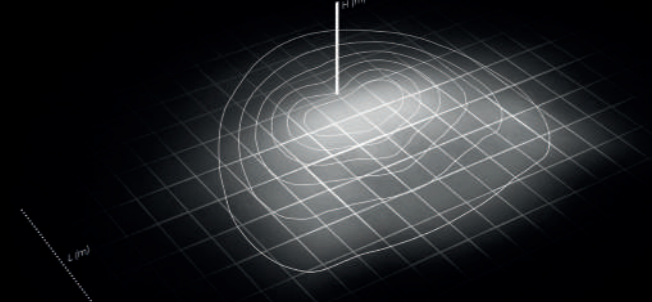

\* only for Spoon Wall

C 10° Narrow Beam \*

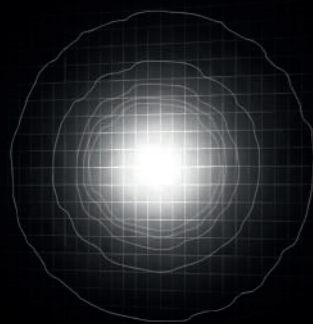

D 45° Wide Beam \*

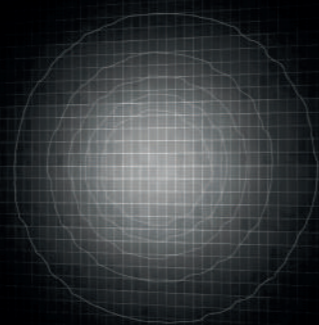

M 25° Medium Beam \*

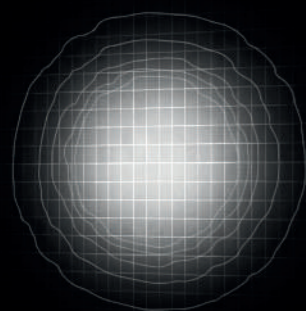

U-D 90° Diffused Beam \*

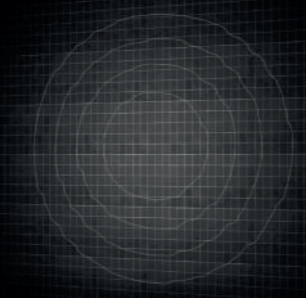

AS-D Asymmetric Diffused Beam

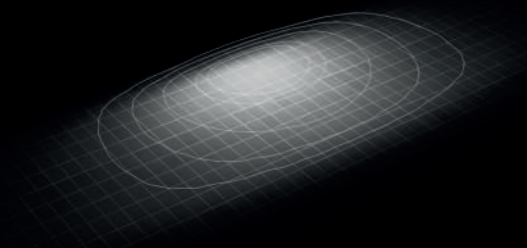

### Spoon Wall, Overdoor

#### DATI TECNICI / TECHNICAL DATA

**Installazione / Installation:**  
parete, sopraporta / wall, overdoor

**Inclinazione / Inclination:**  
-120° + 30° (Spoon Wall)  
0° + 90° (Spoon Overdoor)

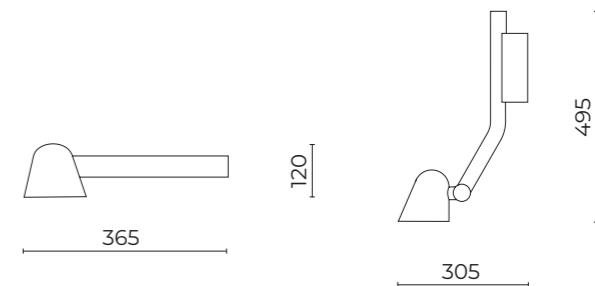



C 11° Narrow Beam

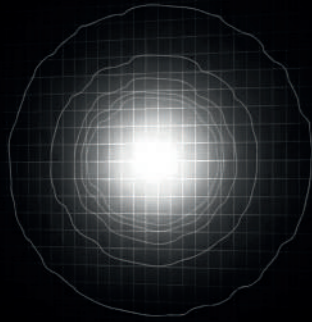

D 40° Wide Beam

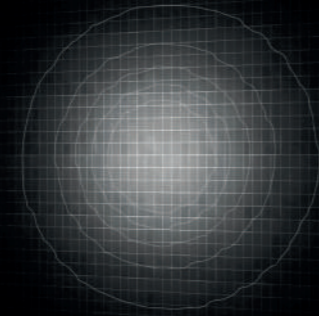

ST-02 Narrow Street  
L / H = 0,75

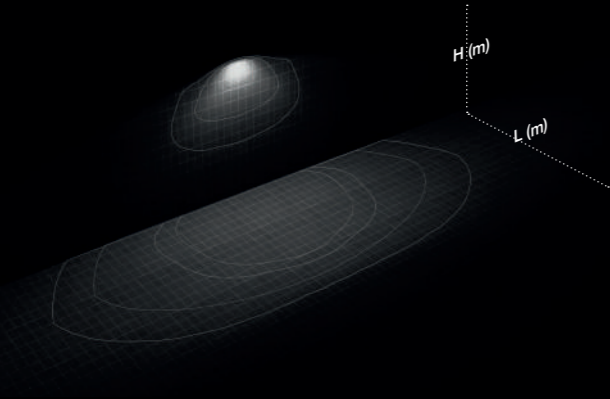

LT-63 Assymetric Beam  
L / H = 2

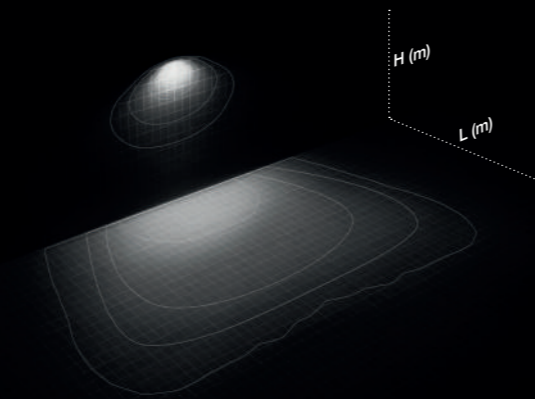

**Spoon**  
Wall

**DATI TECNICI / TECHNICAL DATA**

**Installazione / Installation:**  
parete / wall

**Inclinazione / Inclination:**  
0° ÷ 90°



MEDIUM

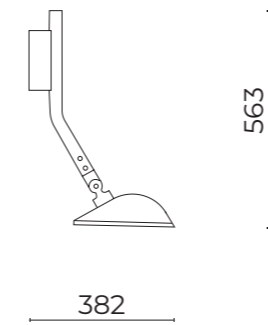

LARGE

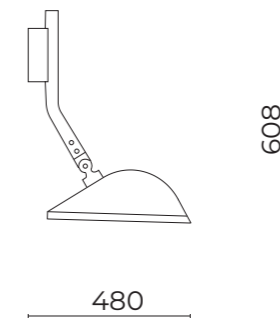

X-LARGE

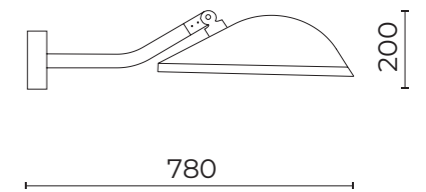
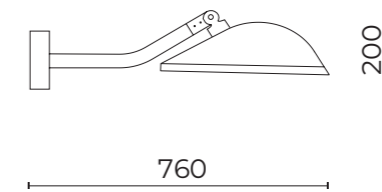
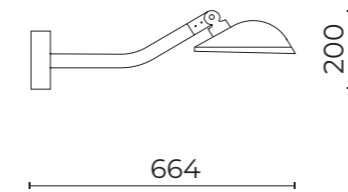
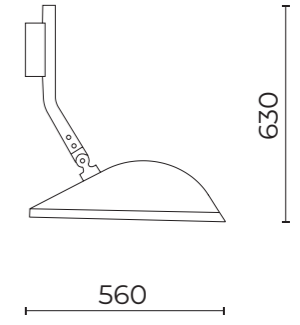

# Spoon

## OTTICHE / OPTICS

C 11° Narrow Beam

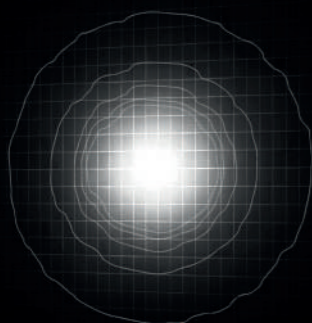

D 40° Wide Beam

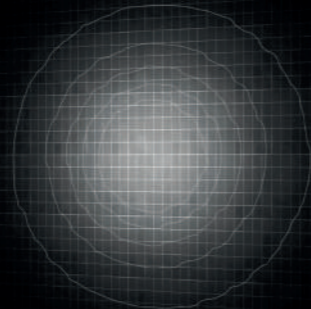

M 25° Medium Beam

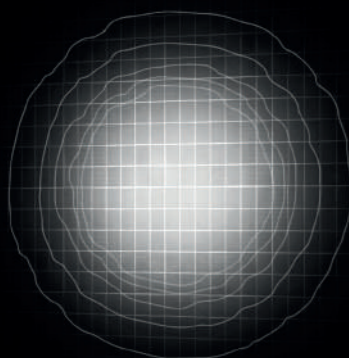

U-D 90° Diffused Beam

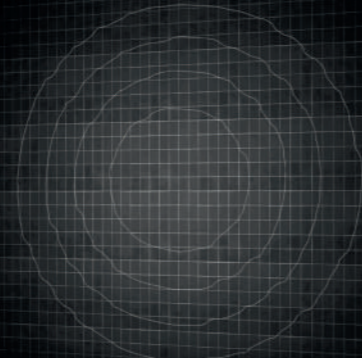

## Spoon Ceiling

### DATI TECNICI / TECHNICAL DATA

**Installazione** / Installation:  
soffitto / ceiling

**Inclinazione** / Inclination:  
0° ÷ 90°



MEDIUM



LARGE

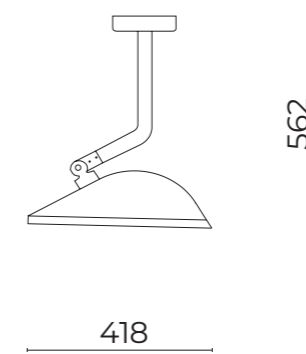

X-LARGE

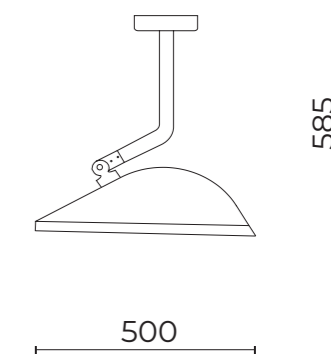



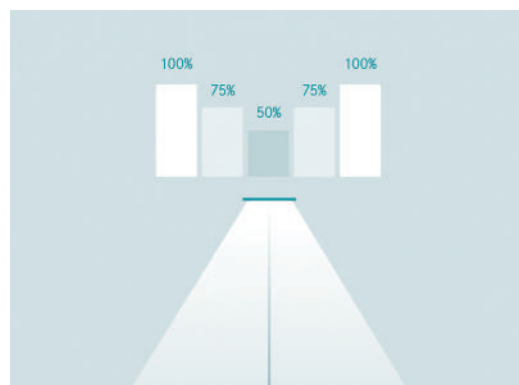

### STAND ALONE: regolazione di flusso in Mezzanotte Virtuale

È una tecnica di riduzione del flusso luminoso stand-alone, completamente integrata in ogni singolo prodotto e che non richiede nuovi cablaggi o dispositivi esterni.

### Autoapprendimento mezzanotte virtuale programmabile custom

La nuova linea Spoon è programmabile custom su richiesta del cliente mediante un algoritmo di mezzanotte virtuale è possibile eseguire una precisa riduzione percentuale del flusso luminoso dell'apparecchio e della potenza elettrica assorbita dall'apparecchio.

Se non diversamente richiesto il prodotto viene fornito con il programma che prevede alla "Mezzanotte Virtuale" una riduzione del flusso al 70% fino a spegnimento.

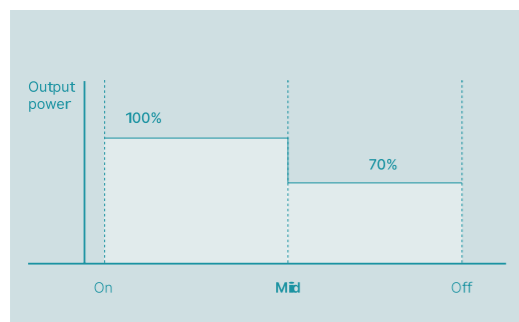

### STAND ALONE: Virtual Midnight flow adjustment

This stand-alone light flow reduction system is built into every individual product and it does not require new wiring or external devices.

### Custom programmable virtual midnight self-learning

Custom programmable versions are available at the customer's request. Using a virtual midnight algorithm, a precise reduction can be made in the luminaire's luminous flux percentage and its electrical power input.

Unless otherwise requested, the product is supplied with a program that reduces the light flux to 70% at "Virtual Midnight" until it switches off.

### DALI

È un controllo di tipo digitale, dove ad ogni apparecchio viene assegnato un indirizzo univoco, che permette il controllo del singolo punto luce e la creazione di gruppi di controllo.

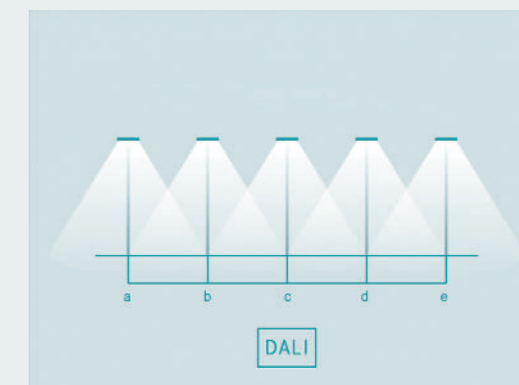

### DALI

This is a digital type control system where every device is assigned a unique address that allows the individual light points to be controlled and the control units to be created.

### IOT

Spoon, nelle versioni large e x-large, può essere equipaggiato con dispositivi che abilitano l'IoT su scala urbana. Grazie ai connettori ZHAGA, installabili sul lato superiore del prodotto, sensori e antenne possono essere aggiunti contestualmente all'installazione o successivamente.



### IOT

Spoon, in the large and x-large versions, can be fitted with devices that enable IoT on an urban scale. Thanks to ZHAGA connectors, available on the top of the product, sensors and aerials can be added to the product during or after installation.

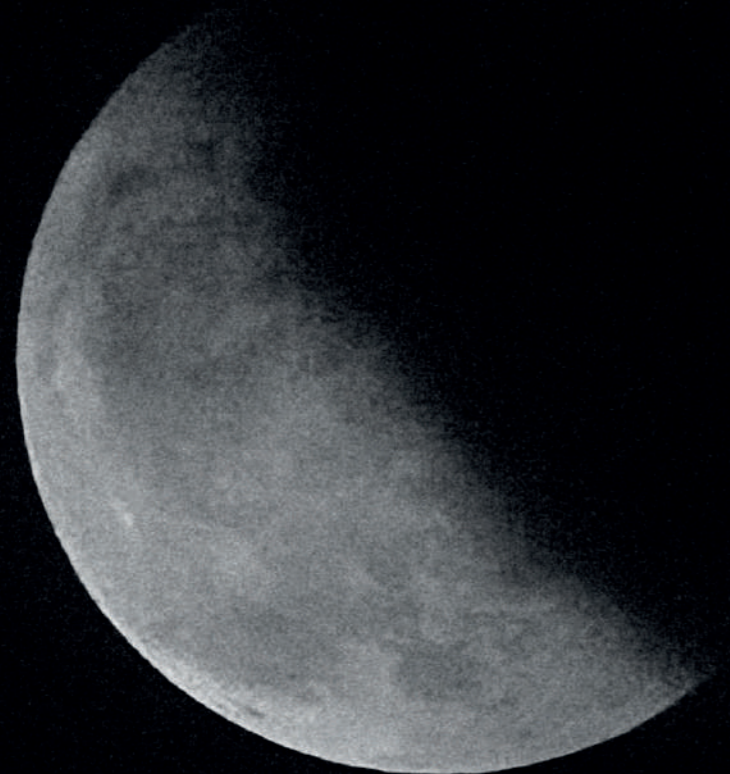

# ECO-CENTRIC LIGHTING

Eco-Centric Lighting è l'approccio alla progettazione illuminotecnica degli spazi esterni che mira a tutelare la biodiversità e il benessere umano. Le nostre soluzioni limitano l'inquinamento luminoso e garantiscono la sicurezza e il comfort visivo delle persone.





Eco-Centric Lighting is an approach to the lighting design of outdoor spaces that aims to protect biodiversity and human well-being. Our solutions limit light pollution and ensure people's safety and visual comfort.







DISCOVER MORE

# DARK FRIENDLY LIGHT

L'illuminazione artificiale notturna è una necessità per l'uomo ma è anche una concreta minaccia per i ritmi biologici naturali di flora e fauna. Le soluzioni Dark Friendly possono preservare il buio della notte e limitare l'inquinamento luminoso offrendo al progettista:

- 
 • luce calda secondo necessità: dal bianco neutro all'ambra
- 
 • luce quando serve: intelligente e adattiva
- 
 • luce dove serve: diretta verso il basso
- 
 • luce quanto serve: regolabile e minimizzata

Artificial lighting at night is a need for humans but is also a real threat to the natural biological rhythms of flora and fauna. Dark Friendly solutions can preserve the darkness of the night and limit light pollution offering to designer:

- 
 • light warm as needed: from neutral white to amber
- 
 • light when is needed: smart and adaptive
- 
 • light where is needed: downward directed
- 
 • light how much is needed: adjustable and minimized





# BLUE FREE LIGHT

I sistemi ottici Blue Free riducono il contenuto di blu della luce bianca e generano un'atmosfera calda e accogliente per le persone. Sono ideali per illuminare spazi e percorsi di notevole interesse ecologico e prevalentemente frequentati da pedoni o ciclisti.

Blue Free optical systems reduce the blue content of white light and generate a warm and welcoming atmosphere for people. They are ideal for lighting spaces and paths of significant ecological interest and mainly used by pedestrians or cyclists.

PHOSPHOR CONVERTED AMBER (PCA) LED

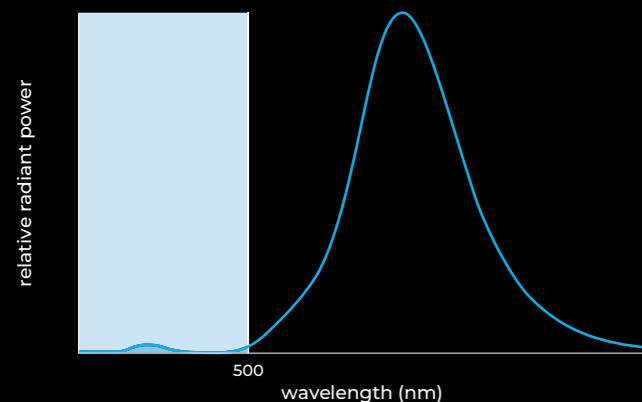

1800K LED

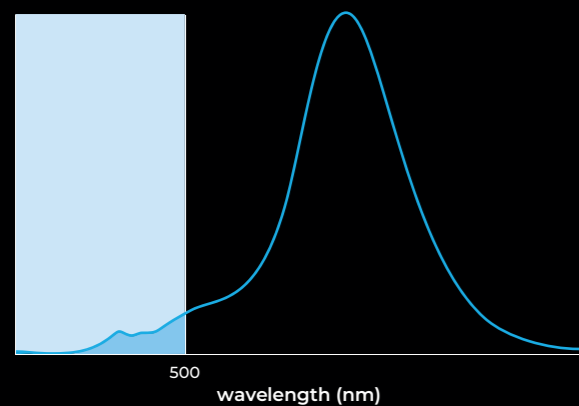

DISCOVER MORE

# SWITCHABLE WHITE LIGHT

I sistemi ottici Switchable White alternano una luce ambrata a ridotto contenuto di blu (CCT=1800K), che protegge la flora e la fauna, con una luce bianca calda (CCT=3000K), che migliora le prestazioni visive umane quando il traffico è più intenso. Questa soluzione è ideale per illuminare spazi e percorsi ibridi, ecologicamente interessanti ma anche percorribili da veicoli.

The Switchable White optical systems alternate an amber light with reduced blue content (CCT=1800K), which protects the flora and fauna, with a warm white light (CCT=3000K), which improves human visual performance when traffic is heavier. This solution is ideal for lighting hybrid spaces and paths, which are ecologically interesting but also traveled by vehicles.

3000K LED

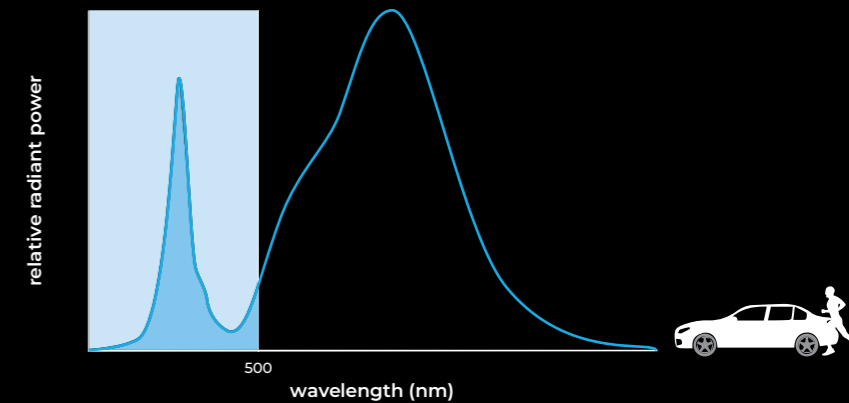

1800K LED

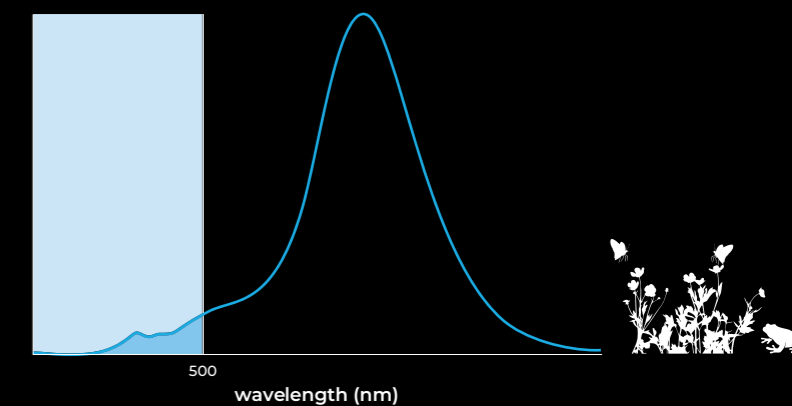









I dati qui pubblicati non sono impegnativi. Cariboni Group, in favore di un costante miglioramento dei propri prodotti, si riserva di apportare senza preavviso le opportune modifiche.

The data published here are not binding. Cariboni Group, in favor of a constant improvement of its products, reserves the right to make changes without notice.

[caribonigroup.com](http://caribonigroup.com)

