

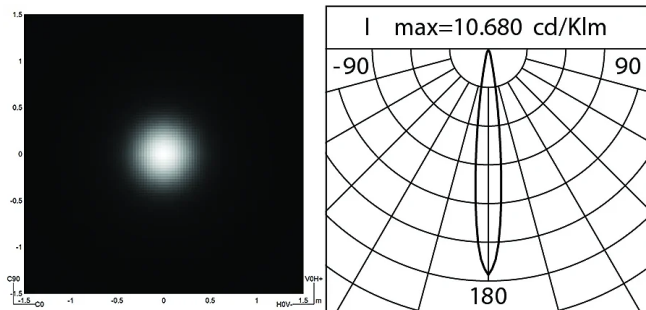

General Features

Description:	LED bollard
Insulation class:	class III
Rated voltage:	36Vdc
Protection Grade:	IP66
Impact protection:	IK09
Power Factor:	> 0.9
Ambient temperature Ta:	-20°C +50°C
Weight:	4 kg
Max exposed surface:	0.019 m ²
Lateral exposed surface:	0.050 m ²
Driver:	remote (to be ordered separately)
Marks and Certifications:	CE

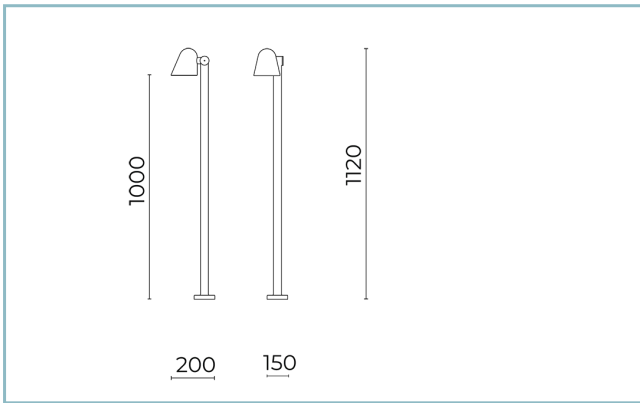

Performance Data*

LED Current:	350 mA
Source flux:	1630 lm
Source power:	13 W
Source efficiency:	125 lm/W
Device flux:	1150 lm
Device power:	13 W
Appliance efficiency:	88 lm/W
Glare Index Category:	D6

Product Sheet

06/06/2024

Spoon Bollard

Size: H 1000

Options: DALI

Color Temperature: 3000 K

Type of optics: C 10° Narrow Beam

06SN1A1359A8G6V

Colour: Champagne

Optical System

Source: CoB LED

Color Temperature: 3000 K

Color Rendering Index (CRI): ≥ 90 Chromatic consistency (SDCM): ≤ 3

Type of optics: C 10° Narrow Beam

Optical group life: > 100.000 h @ 350mA @ Ta 25° C TM21 L80B10

Photobiological safety class: EXEMPT GROUP

ULOR: 0%

DLOR: 100%

Light intensity category: G*6

BUG rating: B1-U0-G0

Normative References

EN60598-1 / EN60598-2-3 / IEC / TR62778 / EN62471 / EN61547

Installation and maintenance

Installation: ground

Tilt: $0^\circ \div 180^\circ$, rotation $\pm 30^\circ$ \varnothing power cable: $3,5 \div 7$ mm

Cable Gland: M12x1,5

Power supply compartment: independent from the optical group

Flow adjustment

Standard

DALI control

X

MaterialsBody: die-cast aluminium alloy UNI EN AB 47100 (copper content $< 1\%$)

Screen: tempered flat glass

Lenses: highly transparent technopolymer lenses

Fixing system: die-cast aluminium alloy UNI EN AB 47100 (copper content $< 1\%$)

Seals: expanded anti-age silicone foam

Screws: stainless steel AISI 304

Wiring plate: zinc-plated steel

Finish: phospho-chromatation treated and polyester powder-coated in 16 phases to increase weather resistance

Colors ChampagneCode: **06SN1A1359A8G6V**

Complements

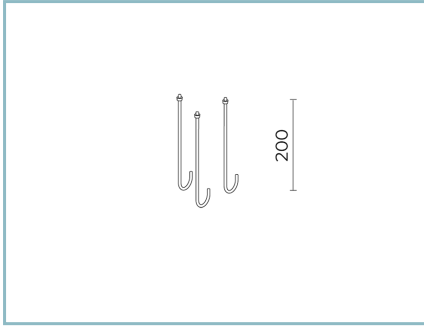

06PY999X0

Anchoring bolts kit
L=200 mm.

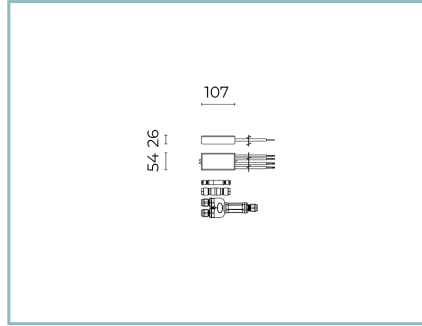

06SN901X0

D18 Kit DALI driver
30W 350mA IP67 (N. 1 Spoon Small)

NOTES

*Performance data

The values indicated in this data sheet are nominal values with a tolerance of +/-7%.

Source flux and source efficiency data refer to the LED module without optics; in case you are interested in the performance of the LED module complete with optical system, you must multiply the data reported by the factor 0.9.

General Data

The characteristics of the product listed may be subject to change and must be confirmed when ordering.

In order to promote constant updating of its products, Cariboni Group reserves the right to make changes without prior notice.