



### General Features

Description: LED bollard

Insulation class: class II

Rated voltage: 220-240 V 50/60 Hz

Protection Grade: IP66

Impact protection: IK09

Power Factor: > 0.9

Ambient temperature Ta: -20°C +50°C

Weight: 3 kg

Max exposed surface: 0.019 m<sup>2</sup>

Lateral exposed surface: 0.033 m<sup>2</sup>

Driver: included

Driver lifetime: 50.000 h @ 350mA @ Ta 25° C

Marks and Certifications: CE

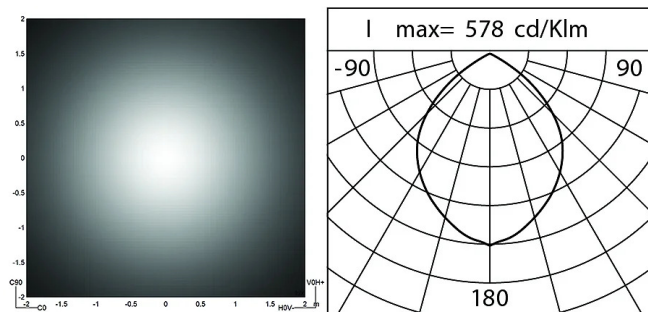
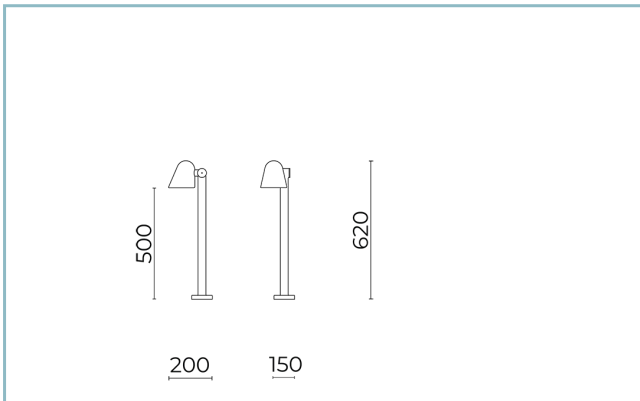

### Performance Data\*

LED Current:	350 mA
Source flux:	1630 lm
Source power:	13 W
Source efficiency:	125 lm/W
Device flux:	980 lm
Device power:	15 W
Appliance efficiency:	65 lm/W
Glare Index Category:	D6

**Product Sheet**

06/06/2024

**Spoon Bollard**

Size: H 500

Options: ON-OFF

Color Temperature: 3000 K

Type of optics: U-D 90° Diffused beam

**06SN0A1359B2G6**

Colour: Champagne

**Optical System**

Source: CoB LED

Color Temperature: 3000 K

Color Rendering Index (CRI):  $\geq 90$ Chromatic consistency (SDCM):  $\leq 3$ 

Type of optics: U-D 90° Diffused beam

Optical group life:  $> 100.000$  h @ 350mA @ Ta 25° C TM21 L80B10

Photobiological safety class: EXEMPT GROUP

ULOR: 0%

DLOR: 100%

Light intensity category: G\*6

BUG rating: B1-U0-G0

**Normative References**

EN60598-1 / EN60598-2-3 / IEC / TR62778 / EN62471 / EN61547

**Installation and maintenance**

Installation: ground

Tilt:  $0^\circ \div 180^\circ$ , rotation  $\pm 30^\circ$  $\varnothing$  power cable: 3,5  $\div$  7 mm

Cable Gland: M12x1,5

Power supply compartment: independent from the optical group

**Materials**Body: die-cast aluminium alloy UNI EN AB 47100 (copper content  $< 1\%$ )

Screen: acid-etched glass

Lenses: highly transparent technopolymer lenses

Fixing system: die-cast aluminium alloy UNI EN AB 47100 (copper content  $< 1\%$ )

Seals: expanded anti-age silicone foam

Screws: stainless steel AISI 304

Wiring plate: zinc-plated steel

Finish: phospho-chromatation treated and polyester powder-coated in 16 phases to increase weather resistance

**Colors** ChampagneCode: **06SN0A1359B2G6**

---

**Product Sheet**

06/06/2024

**Spoon Bollard**

Size: H 500

Options: ON-OFF

Color Temperature: 3000 K

Type of optics: U-D 90° Diffused beam

**06SN0A1359B2G6**Colour: Champagne

---

**Complements**

---

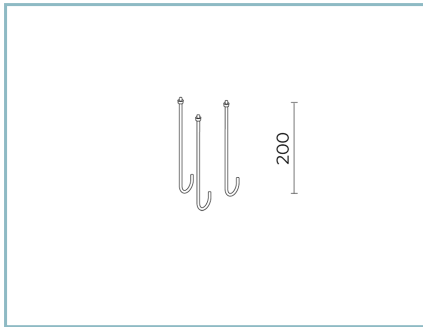

06PY999X0

Anchoring bolts kit

L=200 mm.

---

**NOTES****\*Performance data**

The values indicated in this data sheet are nominal values with a tolerance of +/-7%.

Source flux and source efficiency data refer to the LED module without optics; in case you are interested in the performance of the LED module complete with optical system, you must multiply the data reported by the factor 0.9.

**General Data**

The characteristics of the product listed may be subject to change and must be confirmed when ordering.

In order to promote constant updating of its products, Cariboni Group reserves the right to make changes without prior notice.