

### General Features

Description: recessed LED product

Insulation class: class III

Rated voltage: 24Vdc

Protection Grade: IP67

Impact protection: IK09

Power Factor: > 0.9

Ambient temperature Ta: -30°C +50°C

Weight: 0,4 kg

Driver: to be ordered separately

Marks and Certifications: CE

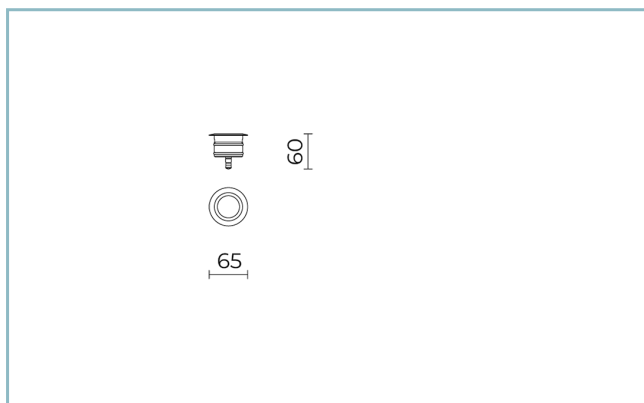

H (m)	Ø (m)	Em (lux)
5	6.6	1
4	5.2	2
3	4	3
2	2.6	6
1	1.3	23

### Performance Data\*

Source flow:	90 lm
Source power:	0.6 W
Source efficiency:	150 lm/W
Device flow:	70 lm
Device power:	0.6 W
Appliance efficiency:	117 lm/W

---

### Optical System

Source: LED

Color Temperature: 3000 K

Color Rendering Index (CRI):  $\geq 80$

Chromatic consistency (SDCM):  $\leq 3$

Type of optics: U-D 90° Diffused beam

Optical group life: >50.000h @Ta25°C L80B10

Photobiological safety class: EXEMPT GROUP

### Normative References

EN60598-1 / EN60598-2-1 / EN62471 / EN61547

### Installation and maintenance

Installation: ceiling, walk over, wall-recessed

Fixing: walk over recessed housing

Wiring: pre-wired product with M8x1 screw connector;  
cable length of 1 m

### Flow adjustment

On request

DALI control

X

### Materials

Body: micro-shot peened stainless steel AISI 316L with  
sanded finish

Screen: tempered flat glass

Lenses: high-transparency PMMA

Seals: anti-age silicone

Screws: stainless steel AISI 304

Finish: AISI 316L stainless steel frame with sandblasted and  
shot peened finish

### Colors

■ sandblasted stainless  
steel AISI 316L

Code: **06CH1A139A7XS**

## Complements

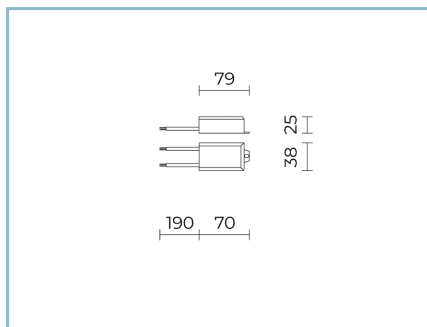

06CH903X0

B147 Driver  
10W-24V IP67

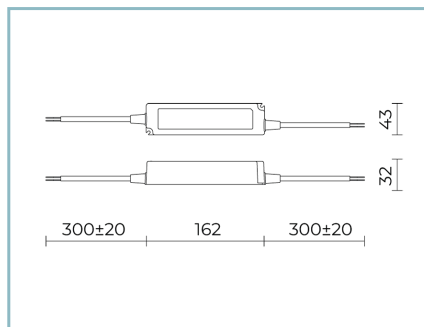

06CH904X0

B148 Driver  
60W-24V IP67

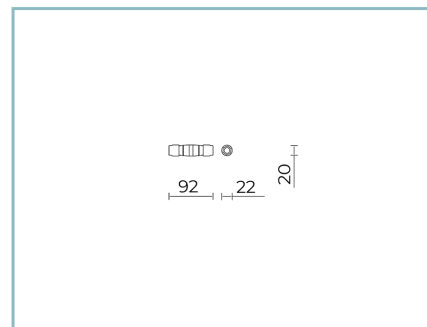

06KS918C0

B137 2 - way connector IP68

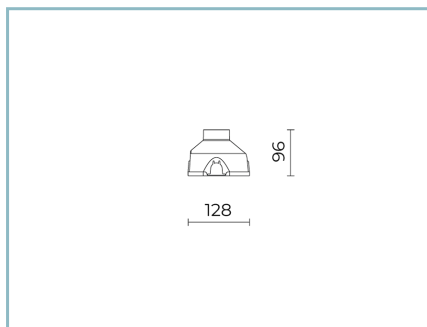

06CH901B0

B130 Walk over and wall recessed housing made of polypropylene. Colour: black RAL9005.

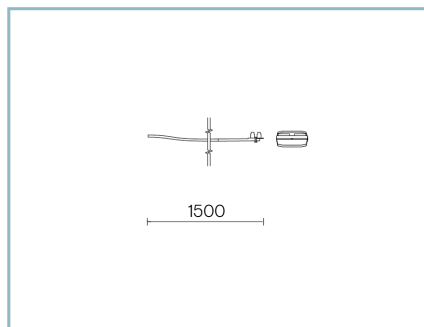

06CH906X0

B198 Kit in/out cable 1,5 m 24 V with junction box

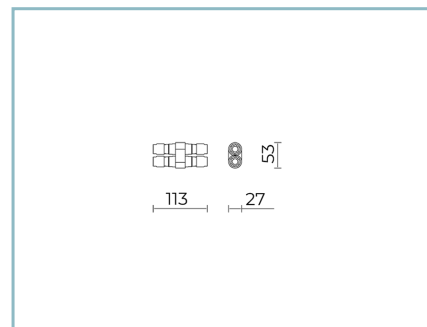

06KS909C0

B89 Connector 4 way IP68

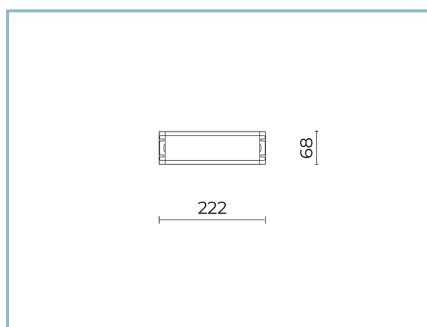

06LL914AB0

DALI driver  
150W-24V IP67

---

**Product Sheet**

Rev. 17/01/2023

**Chara Walk Over Recessed**

Color Temperature: 3000 K

Type of optics: U-D 90° Diffused beam

**06CH1A139A7XS**Colour: sandblasted  
stainless steel AISI  
316L

---

---

**NOTES****\*Performance data**

The values indicated in this data sheet are nominal values with a tolerance of +/-7%.

Source flux and source efficiency data refer to the LED module without optics; in case you are interested in the performance of the LED module complete with optical system, you must multiply the data reported by the factor 0.9.

**General Data**

The characteristics of the product listed may be subject to change and must be confirmed when ordering.

In order to promote constant updating of its products, Cariboni Group reserves the right to make changes without prior notice.